

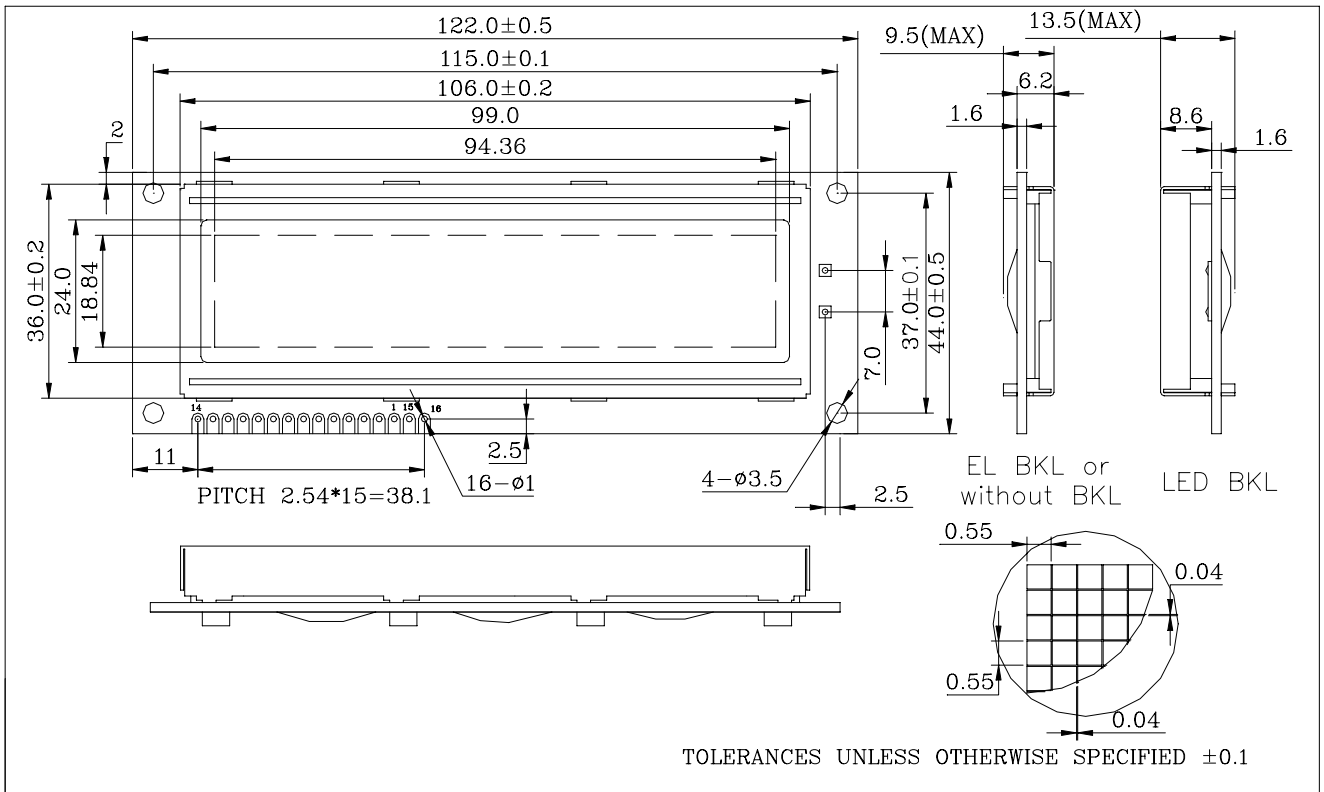

External Dimensions

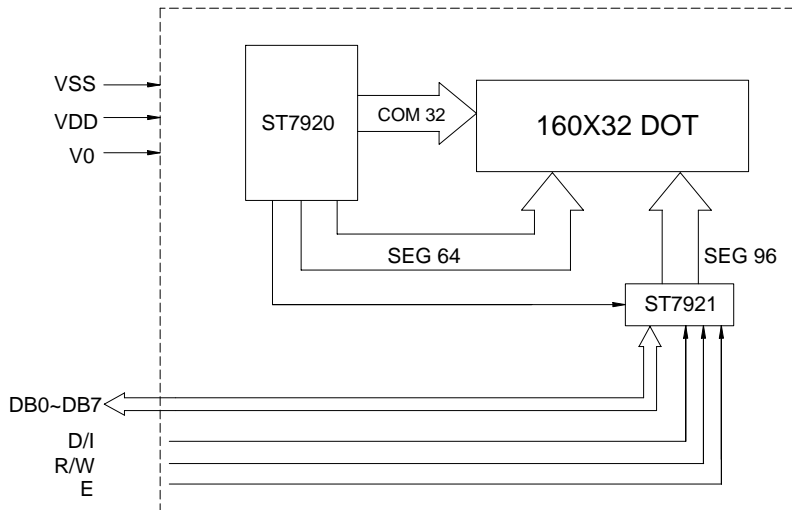

Block Diagram



Power Supply

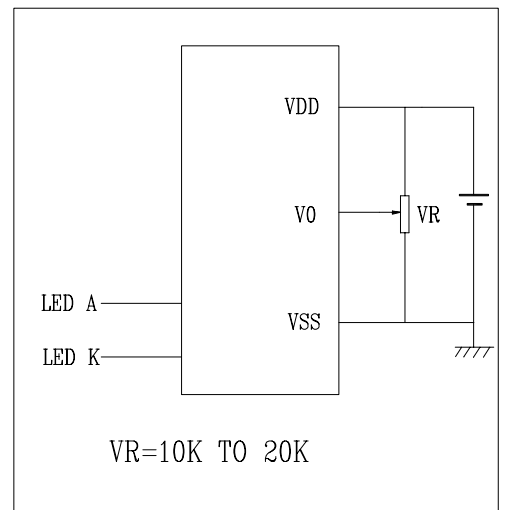

Interface Signals---- J1

Pin	Symbol	Level	Description	Pin	Symbol	Level	Description
1	VSS	0V	Ground	7~14	DB0~DB7	H/L	Data Bus Line
2	VDD	+5V	Supply Voltage for Logic	15	A	--	Back Light anode:+5V
3	V0	--	Operating Voltage for LCD	16	K	--	Back Light cathode:0V
4	R/S(CS)	H/L	H: Data L: Instruction Code				
5	R/W(SID)	H/L	H: Data Read L: Data Write				
6	E(SCLK)	H,H-L	Enable Signal				

Mechanical Specifications

Electrical Specifications

Item	Description(mm)	Item	Symbol	Min	Typ	Max	Unit
Size	122(L)x44(W)x13.5(H)	Supply Voltage for Logic	VDD	4.5	5.0	5.5	V
V.A	99.0(L)x24(W)	Supply Voltage for LCD	VLCD	5.5	6.0	6.5	V
Dot Pitch	0.59x0.59	Supply Current for Logic	IDD		1.0	3.0	mA
Dot Size	0.55x0.55	Supply Current for LED	IF			300	mA